

V-Slim Dotless II (12W/meter type)

Ultra-slim profile of just W8.1 mm(max.point) x H12mm with built-in plug-in connector that allows head-to-head fixture-to-fixture connection with seamless lighting effect.

Suitable for cabinet, niche lighting or other furniture applications.

DC24V

12.0W/m

Indoor
IP44

Ra90 min.
Applicable for all CCT
including 1800K,
2000K 2500K

Dimmable
(DMX, DALI,
0-10V)

3.8W/m available

(⇒ Refer to the separate catalog spec)

R9 90 Ra98(typical) is available a semi-custom spec



Upgraded fixture-built-in connector for V-SLIM DOTLESS II with locking function

FEATURES

- Ultra-slim profile W8.1mm x H12mm.
- Built-in connector that allows head-to-head seamless connection.
- Available in CCT 1800K 2000K 2500K, 2700K 3000K 3500K,4000K
- Reliable/High-efficiency NICHIA LED chip with reverse-polarity protection circuit.
- Minimized voltage drop due to wires running through the whole housing.

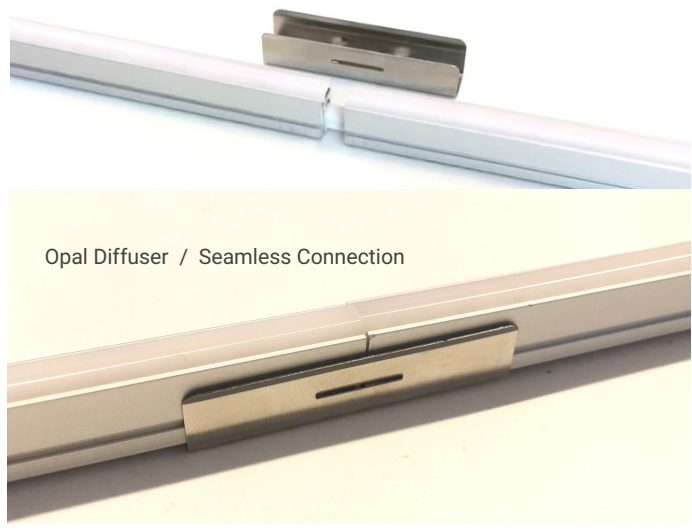

BASIC SPECIFICATION

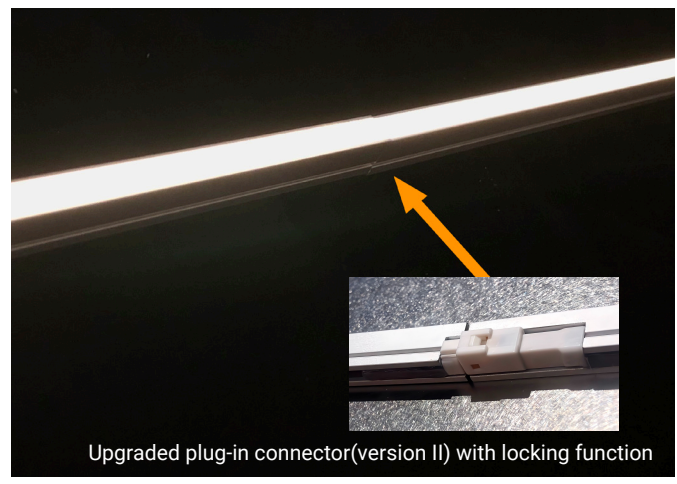
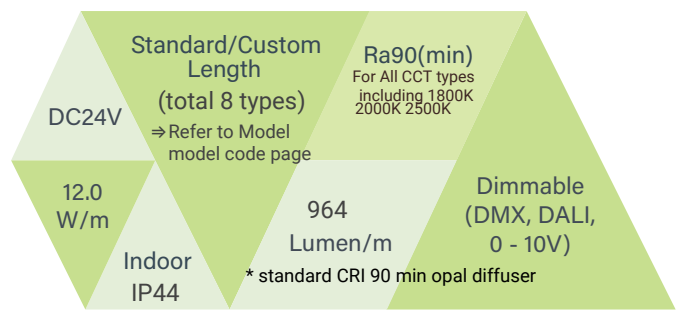

PRODUCT SPECIFICATIONS

Product Name	V-Slim Dotless II				
Model No.	VSDII0331-XXXX	VSDII0661-XXXX	VSDII0826-XXXX	VSDII0991-XXXX	VSDII1156-XXXX
Input Voltage	24Vdc	24Vdc	24Vdc	24Vdc	24Vdc
Power Consumption	4.0 W	7.9 W	9.9 W	11.9 W	13.9 W
Dimension (mm)	331*8.1*12(H)	661*8.1*12(H)	826*8.1*12(H)	991*8.1*12(H)	1156*8.1*12(H)
Weight	65 grams	127 grams	121 grams	181 grams	209 grams
Casing Body	Aluminium Heatsink with UV-resistant Polycarbonate Semi-Frosted Diffuser				
LED Beam Angle	110°	110°	110°	110°	110°
Operating Temperature	-10°C~50°C	-10°C~50°C	-10°C~50°C	-10°C~50°C	-10°C~50°C
Max. Length of Series Connection	4 meter	4 meter	4 meter	4 meter	4 meter
Option Parts	Metal Mounting Bracket 0° (Flat) Type / or Fixture-built-in magnet				
No of LEDs	84	168	210	252	294
Power Supply Unit (Gear-Driver)	Contant-Voltage Switching Power Supply (TDK Lamba, Sold Separately)				
Lumens (typical @ CCT 2700K)	319lm	637lm	796lm	956lm (=964lm per meter)	1,115lm

NOTE: Lumen output of R9 90 Ra98 (typical) semi-custom spec is approx 14% lower than standard spec.

MECHANICAL DRAWING

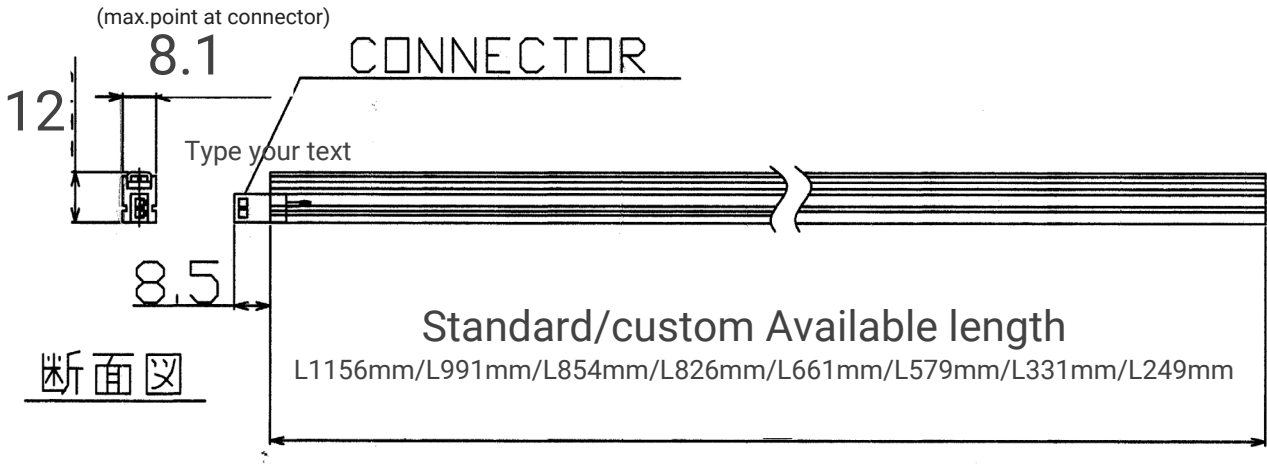

OPTIONAL ACCESSORIES

1 Mounting Clip Bracket 0° Flat Type

Model: MMC-VS-0DEG

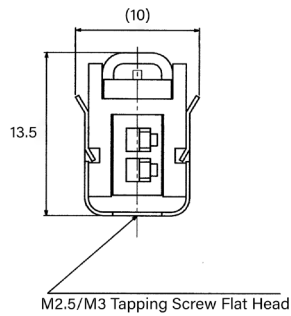
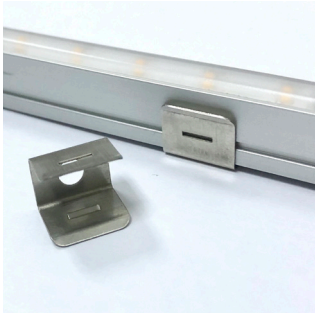

2 Male Harness Connector with L500mm Cable

* Required for first LED Fixture leading to PSU driver

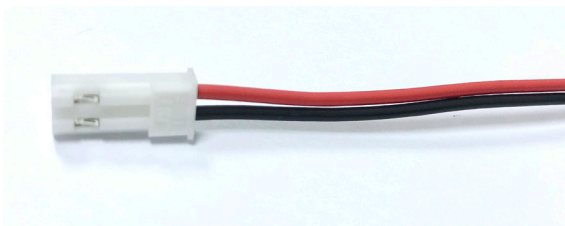

PHOTOMETRICS

BROWNIE Lab 190214

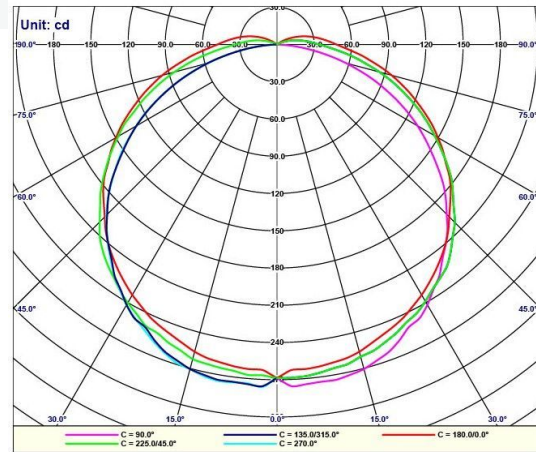

Model: VSDII0991-27XX (L991mm, 12W/m, CCT2700K CRI Ra90min)
 Luminaire Lumen: 956.47lm

3. Magnet (Fixture Built-in)



4. Metal Plate for magnet installation

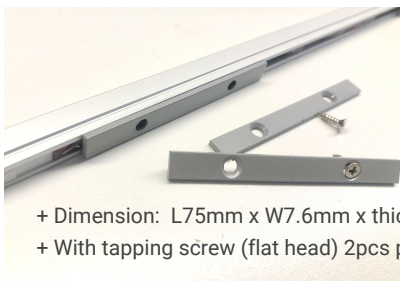

5. Fixture-to-fixture Bracket

Model: MMC-VS-L45

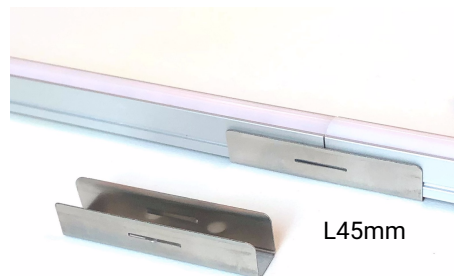

- + Use M2.5/M3 flat head tapping screw (x 2points)
- + The same profile dimension as metal mounting clip 0deg